

ECS-WHT-931

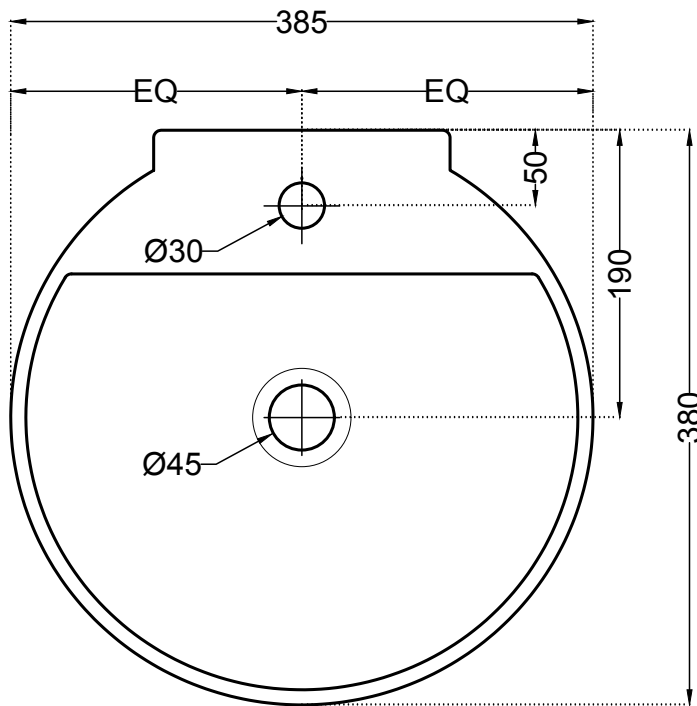

TOP VIEW

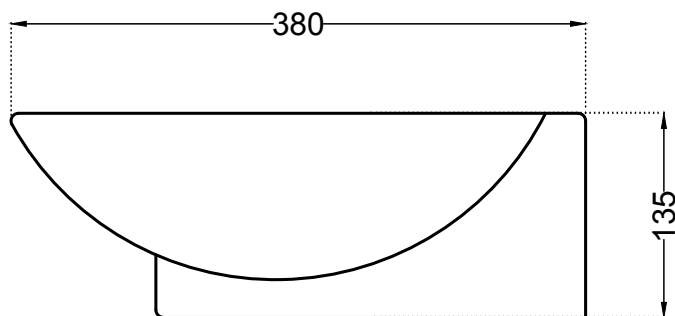

SIDE VIEW

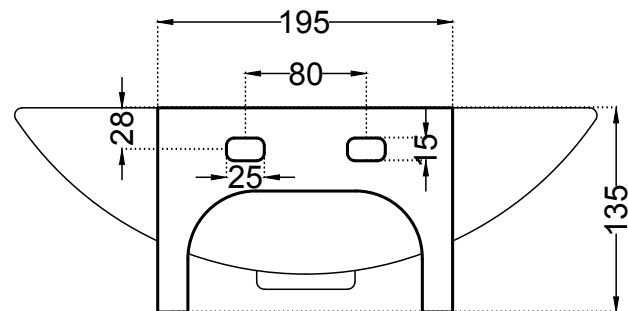

BACK VIEW

ALL DIMENSIONS ARE IN MM. (TOLERANCE ± 5 MM)